



refined environments

1972 West 2425 South, Woods Cross, UT 84087  
801.936.0499 | info@ore.design

# PANEL FIRE FEATURE Models 4033-38

We offer Rail and Slat cladding options. Each is available in two finishes—oak and walnut—Uniquely durable and maintenance-free, we back our woodgrain finishes with a 10-year warranty. Formed of aluminum, our containers and outdoor products are shaped, welded, powder coated (as desired), and packaged exclusively at ORE's independent manufacturing facility in Woods Cross, UT.

**PRODUCT SPECS:** 140 lbs. Aluminum **FIRE MEDIA CAPACITY:** 1 cu. ft. **DIMENSION:** 60" L x 30" W x 18" H

MATERIAL TYPE	FUEL TYPE	BURNER OPTIONS	MODEL #	BTU	ELECTRICAL	EMERGENCY STOPS + TIMER OPTIONS	DESIGN DETAILS + UPGRADES
<input checked="" type="checkbox"/> Aluminum	<input checked="" type="checkbox"/> Natural Gas	<input checked="" type="checkbox"/> Match Lit Burner → TOR-MLFPK36X14-H-FLEX-NG-42X14 →		65K →	-	<input checked="" type="checkbox"/> Mechanical E-Stop/Timer	<input checked="" type="checkbox"/> Powder-Coated Top <input checked="" type="checkbox"/> Media
<input type="checkbox"/> Mild Steel	<input checked="" type="checkbox"/> Liquid Propane	<input type="checkbox"/> Push Button Ignition → - →		- →	-	<input checked="" type="checkbox"/> Electronic Ignition Timer	<input checked="" type="checkbox"/> Black Granite Top <input type="checkbox"/> LED Toe Kick Lighting
<input type="checkbox"/> COR-TEN*	<input type="checkbox"/> Wood Burning (Mild Steel/COR-TEN)	<input checked="" type="checkbox"/> Electronic Ignition → TOR-42X14SSEI-H-NG →		200K →	120 VAC	<input checked="" type="checkbox"/> Emergency Shut Off	<input checked="" type="checkbox"/> Glass Surround <input checked="" type="checkbox"/> Adjustable Feet
	<input type="checkbox"/> 20 LBS LP Tank	<input type="checkbox"/> Match Lit 20 LBS LP Tank → - →		- →	-		<input checked="" type="checkbox"/> Flushed Powder-Coated Lid <input type="checkbox"/> LP Hose Routing
	<input type="checkbox"/> ETHANOL	<input type="checkbox"/> ECOSMART (Ethanol) → - →		- →	-		<input checked="" type="checkbox"/> Raised Powder-Coated Lid <input checked="" type="checkbox"/> Custom Vinyl Covering
							<input checked="" type="checkbox"/> Bollard Controls (EI System) <input type="checkbox"/> 20 LBS Propane Enclosure

## CSA CERTIFIED MATCH LIT BURNER

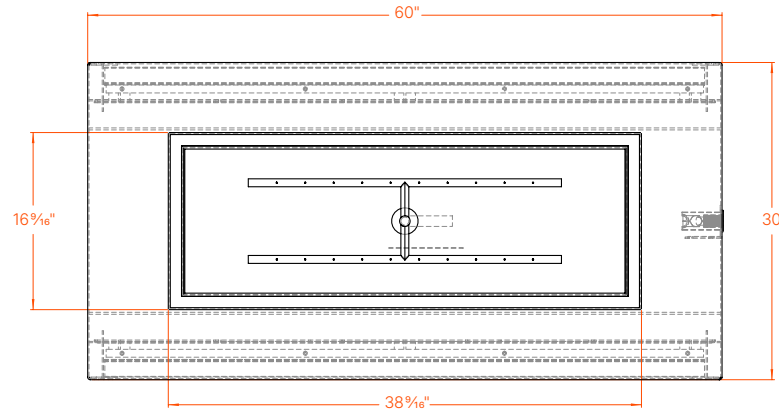
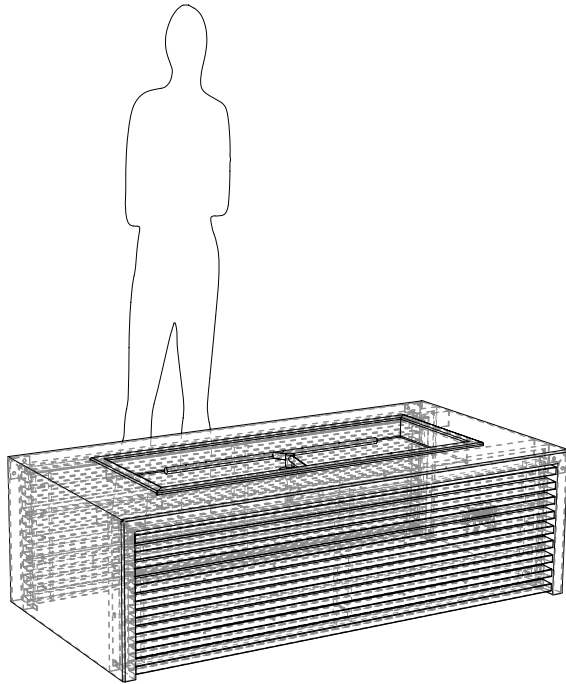

TOP VIEW



4033 product shown in Mottled Zinc finish with Walnut horizontal rail

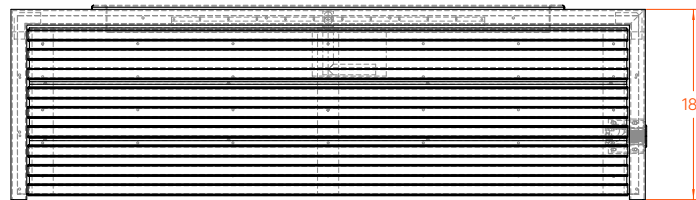

FRONT VIEW

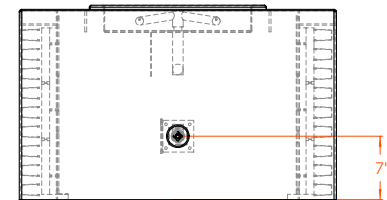

RIGHT VIEW

### READY TO FINALIZE YOUR QUOTE?

Send us your project and finish details to connect with our account reps and project managers and bridge the gap from design intent to fabrication.

Quote Link → <https://ore.design/quote/>



refined environments

1972 West 2425 South, Woods Cross, UT 84087  
801.936.0499 | info@ore.design

# PANEL FIRE FEATURE Model 4033-38

**STANDARD OPTIONS:** The Panel Fire Feature base model is provided with a CSA certified, 65 k B.T.U. match-lit burner (see first page for dimensions). A removable cover is required with an electronic ignition burner. While fire feature dimensions do not change with each option, there may be variations on the top face when selecting your burner. Our Project Managers are on hand to discuss additional options to complement your burner selection.

**CAUTION:** Please follow operating instructions carefully. Fire Features are for outdoor/interior use only.

## FLUSHED, POWDER-COATED LID WITH CSA CERTIFIED PILOTLESS REMOTE ELECTRONIC IGNITION

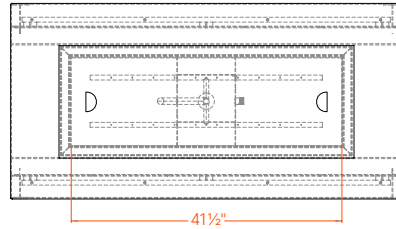
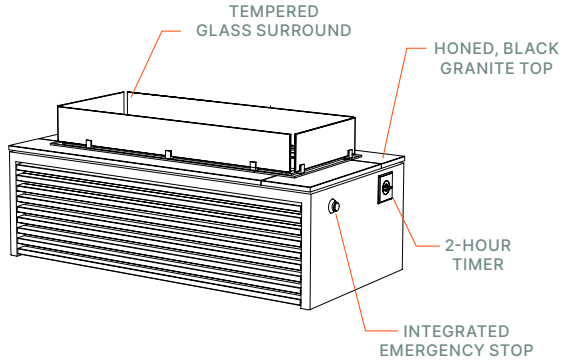

TOP VIEW

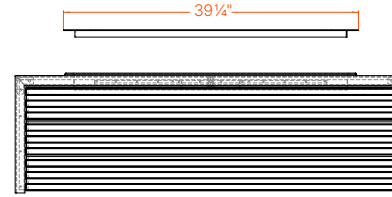

FRONT VIEW

FLUSHED POWDER-COATED LID  
(SEE SPEC SHEET FOR OPTIONS)

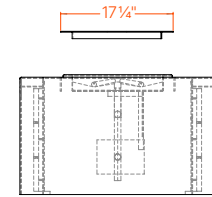

RIGHT VIEW

## GLASS SURROUND, FLUSHED LID, BLACK GRANITE TOP WITH CSA CERTIFIED PILOTLESS REMOTE ELECTRONIC IGNITION



4035 product shown in Titanium Grey finish with Walnut vertical rail

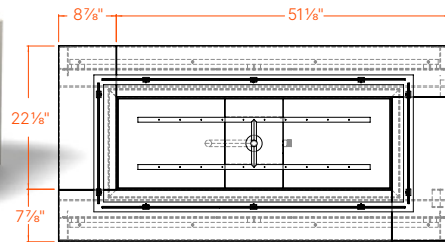

TOP VIEW

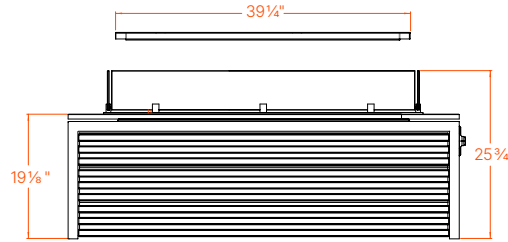

FRONT VIEW

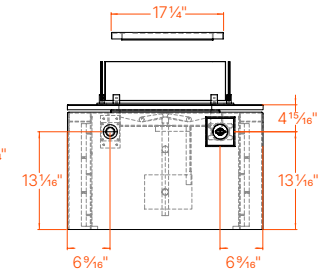

RIGHT VIEW

## GLASS SURROUND DETAILS



Product 4038 shown in Graphite finish with Oak slat

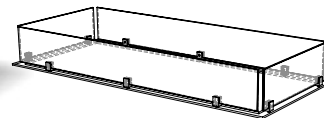

PERSPECTIVE VIEW

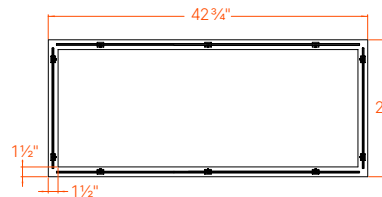

TOP VIEW

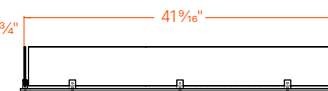

FRONT VIEW

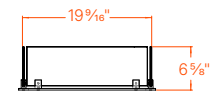

RIGHT VIEW

801.936.0499 | INFO@ORE.DESIGN

SPC-FF-PNL-AR01 0426

ORE.DESIGN

©2026 ORE Design, Inc. All rights reserved. Information in this document is confidential and is exclusive property of ORE Design, Inc. Delivery of this document or any copy thereof or disclosure of such information to unauthorized persons is forbidden without expressed written permission of ORE Design, Inc.