



132 Pierpont Avenue, Garden Level
 Salt Lake City, UT 84101
 info@ore.design | 801.936.0499
ore.design

4014 CYLINDER FIRE PIT

PRODUCT DESCRIPTION: The CYLINDER FIRE PIT provides a strong, sculptural look in a variety of colors, adding dimension to design plans. This firepit may be fitted for natural gas, propane (LP) , or EcoSmart bioethanol.

CAUTION: Please follow operating instructions carefully. Firepits are for outdoor/interior use only.

4014 CYLINDER FIRE PIT: WEIGHT: 111 lbs. Steel | 55 lbs. Aluminum CAPACITY: 0.25 cu ft DIMENSION: 36" Dia x 18"H
 *Standard Glass Rock: 0.5" - 1" glass rock, 3" deep. Available colors include: brown, black, blue, green, pearl, pink, purple, teal, turquoise & white
 *Premium Glass Rock: 0.5" - 1" glass rock, 3" deep. Available colors include: red, yellow and orange *Granite Top adds approximately 70 lbs to the final weight.

Formed of either steel or aluminum, our containers and outdoor products are shaped, welded, powder coated (as desired), and packaged exclusively at Ore's independent manufacturing facility in Salt Lake City, Utah.
 For more information, please contact your Ore Project Manager.

OPTIONS:       

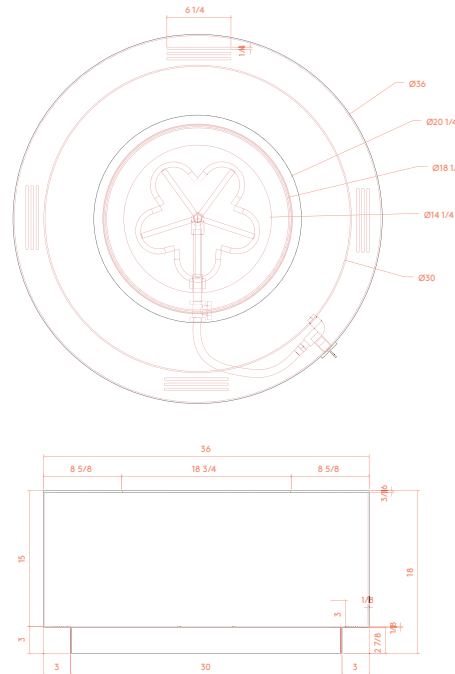

4014 | Fire Bowl in Standard Powder Coat Charcoal Gray

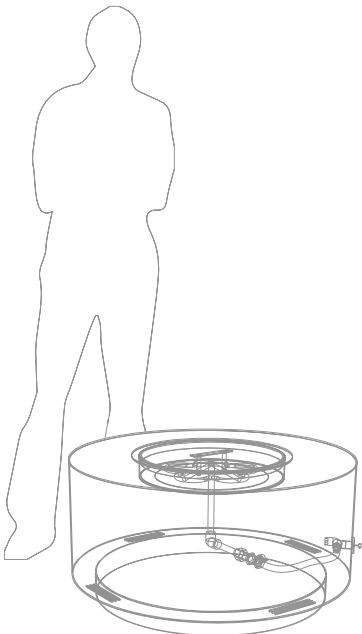

LEED® POINTS:

- 1) Material Content
- 2) Indoor Environmental Quality - Manufacturing
- 3) Indoor Environmental Quality - Low VOCs
- 4) Material Reuse
- 5) Proximity

Final points achieved will vary according to materials and destination.

LEGAL INFORMATION:

ALL RIGHTS RESERVED. INFORMATION IN THIS DOCUMENT IS CONFIDENTIAL AND IS EXCLUSIVE PROPERTY OF ORE INCORPORATED. DELIVERY OF THIS DOCUMENT OR ANY COPY THEREOF OR DISCLOSURE OF SUCH INFORMATION TO UNAUTHORIZED PERSONS IS FORBIDDEN WITHOUT EXPRESSED WRITTEN PERMISSION OF ORE INC.

TO SPECIFY THIS PRODUCT:

- 1) Indicate product name, product number, description, and size.
- 2) Select material: recycled steel, COR-TEN, or recycled aluminum. If recycled steel or aluminum is specified, select powder-coat color or natural patina finish.
- 3) Select product-specific options. Standard options may be viewed at ore.design.



132 Pierpont Avenue, Garden Level
 Salt Lake City, UT 84101
 info@ore.design | 801.936.0499
ore.design

4014 CYLINDER FIRE PIT

Standard Options: The CYLINDER FIRE PIT base model provides a deep pan and mesh screen for wood-burning fires. This product may also be fitted with the options below. While firepit dimensions do not change with each option, there may be variations on the top face when selecting your burner. Our Project Managers are on hand to discuss additional options to complement your burner selection.

Please note that firepits are for outside use only, regardless of burner selection.

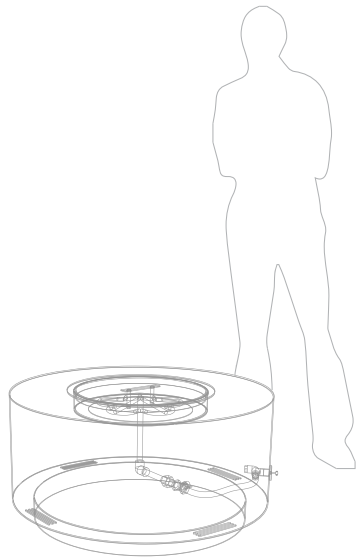

CSA CERTIFIED MATCH LIT BURNER

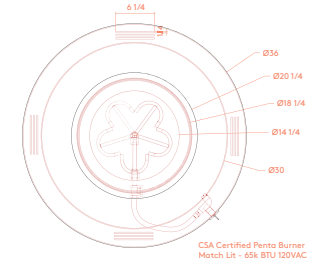
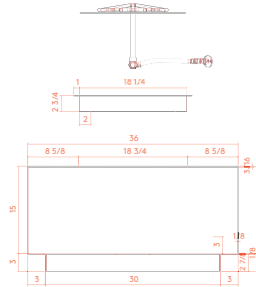
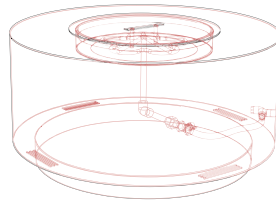

CSA Certified Pentto Burner
 Match Lit - 65k BTU 120VAC

CSA CERTIFIED PILOTLESS REMOTE ELECTRONIC IGNITION

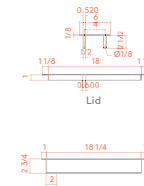
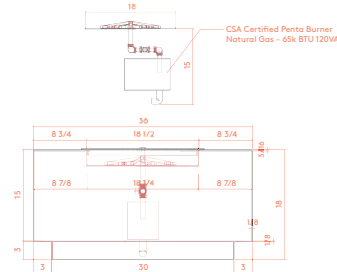
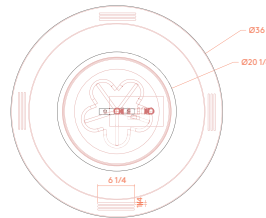

CSA Certified Pentto Burner
 Natural Gas - 65k BTU 120VAC

GLASS SURROUND

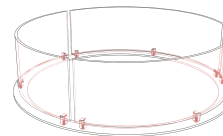
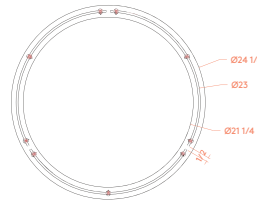

FRONT ELEVATION



RIGHT ELEVATION



4014 | Fire Bowl in Standard Powder
 Coat Charcoal Gray

LEGAL INFORMATION:

ALL RIGHTS RESERVED. INFORMATION IN THIS DOCUMENT IS CONFIDENTIAL AND IS EXCLUSIVE PROPERTY OF ORE INCORPORATED. DELIVERY OF THIS DOCUMENT OR ANY COPY THEREOF OR DISCLOSURE OF SUCH INFORMATION TO UNAUTHORIZED PERSONS IS FORBIDDEN WITHOUT EXPRESSED WRITTEN PERMISSION OF ORE INC.