



refined environments

1972 West 2425 South, Woods Cross, UT 84087
801.936.0499 | info@ore.design

SQUARE FIRE FEATURE Model 4011

The Square Fire Feature adds a modern, yet rustic feel to outdoor spaces. The fire feature may be fitted for natural gas or propane (LP). Formed of either steel or aluminum, our containers and outdoor products are shaped, welded, powder coated (as desired), and packaged exclusively at ORE's independent manufacturing facility in Woods Cross, UT.

PRODUCT SPECS: 45 lbs. Aluminum | 85 lbs. Steel **FIRE MEDIA CAPACITY:** 1 cu. ft. **DIMENSION:** 34" L x 34" W X 18" H

MATERIAL TYPE	FUEL TYPE	BURNER OPTIONS	MODEL #	BTU	ELECTRICAL	EMERGENCY STOPS + TIMER OPTIONS	DESIGN DETAILS + UPGRADES
<ul style="list-style-type: none"> Aluminum Mild Steel COR-TEN* 	<ul style="list-style-type: none"> Natural Gas Liquid Propane Wood Burning (Mild Steel/COR-TEN) 20 LBS LP Tank ETHANOL 	<ul style="list-style-type: none"> Match Lit Burner Push Button Ignition Electronic Ignition Match Lit 20 LBS LP Tank ECOSMART (Ethanol) 	<ul style="list-style-type: none"> MLFPK18SQ-FLEX-NG FPPK18-SQ-FLEX-NG 18FSSEI-SQ-NG MLFPK18SQ-FLEX-LP-ST ECO BK5 	<ul style="list-style-type: none"> 65K 90K 65K 65K 13K 	<ul style="list-style-type: none"> - Battery 120 VAC - - 	<ul style="list-style-type: none"> Mechanical E-Stop/Timer Electronic Ignition Timer Emergency Shut Off 	<ul style="list-style-type: none"> Powder-Coated Top Black Granite Top Glass Surround Flushed Powder-Coated Lid Raised Powder-Coated Lid Bollard Controls (EI System) Media LED Toe Kick Lighting Adjustable Feet LP Hose Routing Custom Vinyl Covering 20 LBS Propane Enclosure

SPARK ARRESTOR WITH CSA CERTIFIED MATCH LIT BURNER

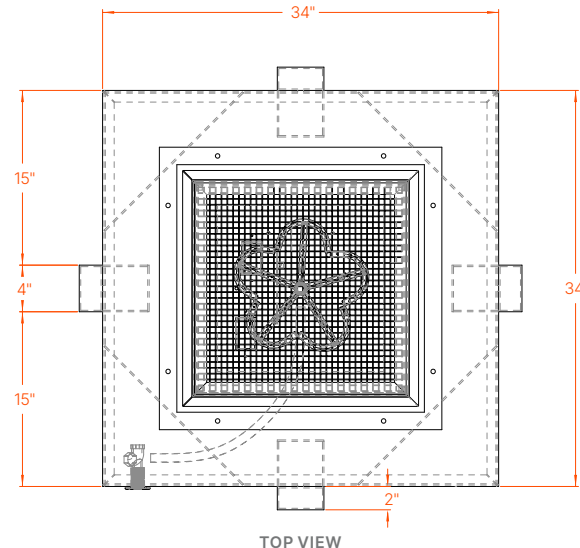
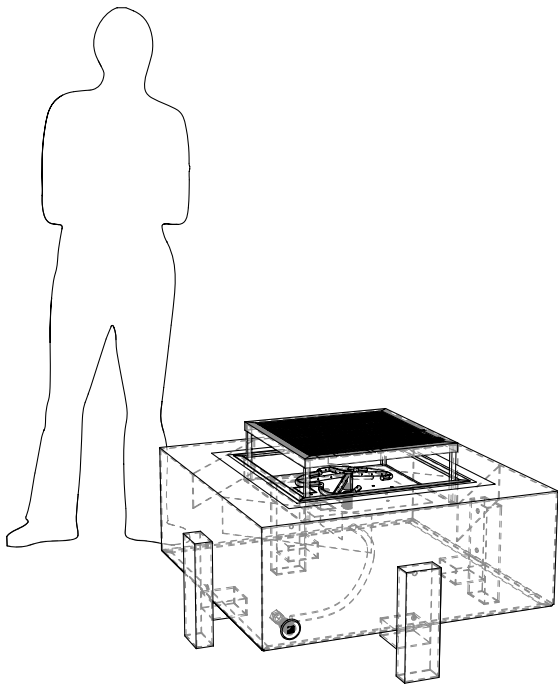

TOP VIEW

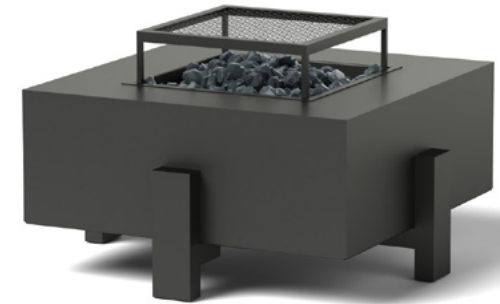

Product shown in Cast Pewter finish

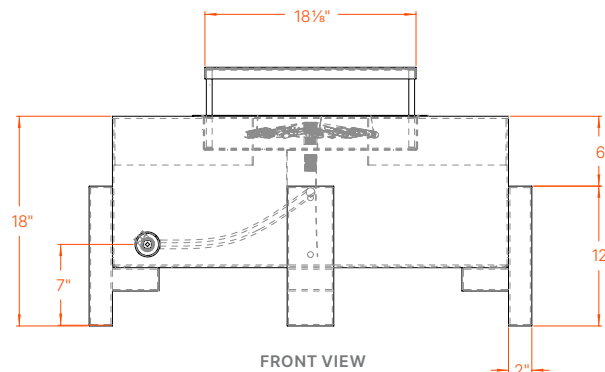

FRONT VIEW

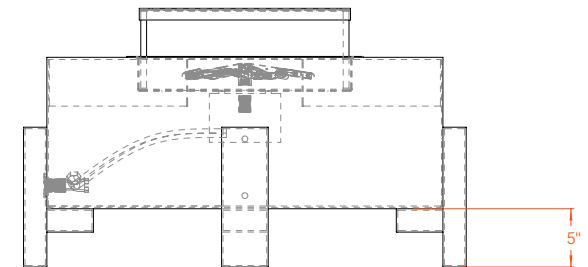

RIGHT VIEW

READY TO FINALIZE YOUR QUOTE?

Send us your project and finish details to connect with our account reps and project managers and bridge the gap from design intent to fabrication.

Quote Link → <https://ore.design/quote/>



refined environments

SQUARE FIRE FEATURE Model 4011

STANDARD OPTIONS: The Square base model provides a pan for wood-burning fires and may fitted with the options below. Our Project Managers are on hand to discuss additional options to complement your burner selection.

1972 West 2425 South, Woods Cross, UT 84087
801.936.0499 | info@ore.design

CAUTION: Please follow operating instructions carefully. Fire features are for outdoor/external use only.

FLUSHED, POWDER-COATED LID WITH CSA CERTIFIED PILOTLESS REMOTE ELECTRONIC IGNITION

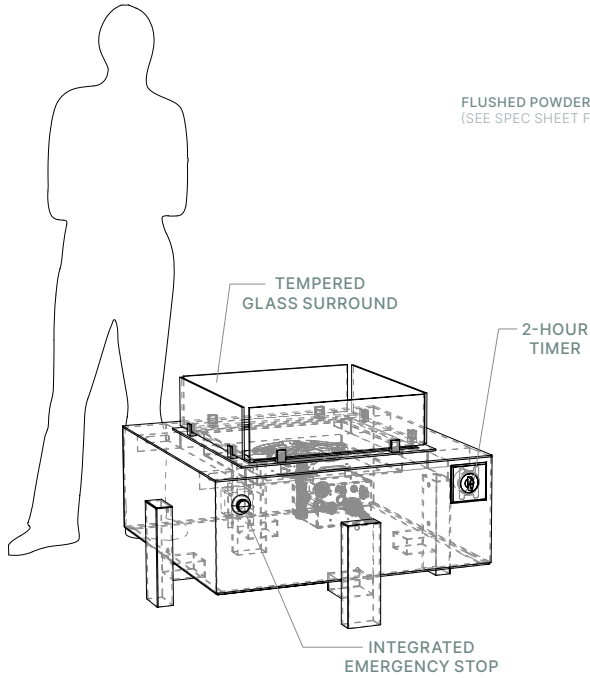

FLUSHED POWDER-COATED LID
(SEE SPEC SHEET FOR OPTIONS)

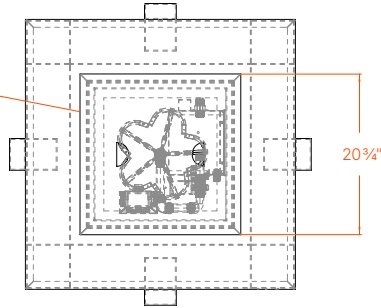

TOP VIEW

RAISED POWDER-COATED LID
(SEE SPEC SHEET FOR OPTIONS)

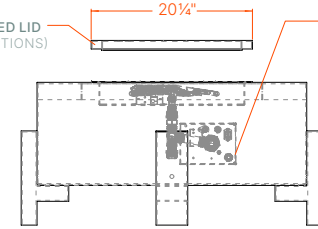

FRONT VIEW

TEMPERED GLASS SURROUND AND HONED, GRANITE TOP WITH CSA CERTIFIED PILOTLESS REMOTE ELECTRONIC IGNITION

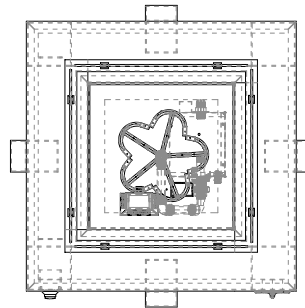

TOP VIEW

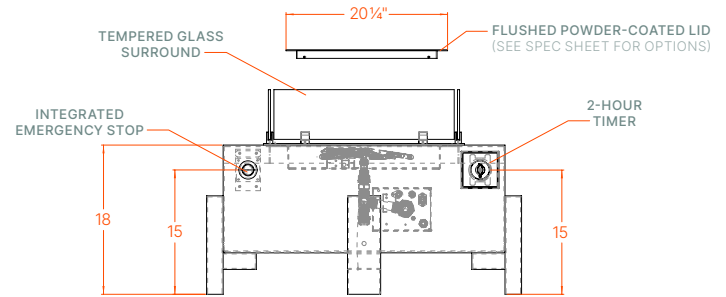

FRONT VIEW

GLASS SURROUND DETAILS

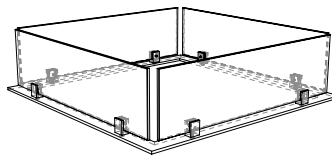

PERSPECTIVE VIEW

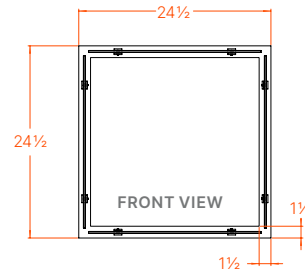

FRONT VIEW

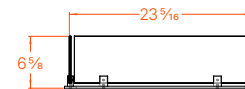

TOP VIEW

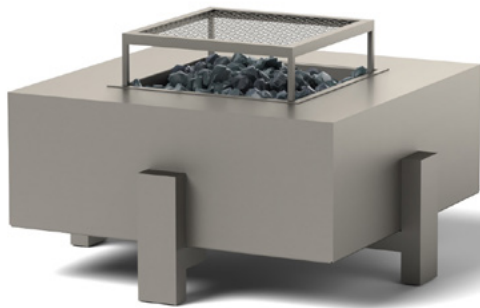

Product shown in Titanium Grey finish

801.936.0499 | INFO@ORE.DESIGN

SPC-FF-SQR-AR01 0426

©2026 ORE Design, Inc. All rights reserved. Information in this document is confidential and is exclusive property of ORE Design, Inc. Delivery of this document or any copy thereof or disclosure of such information to unauthorized persons is forbidden without expressed written permission of ORE Design, Inc.

ORE.DESIGN